

2017



Enjoy your ride!

ALHONGA

2017 PRODUCT GUIDE

35
YEARS



MORE HISTORY.
MORE BIKE.

ABOUT ALHONGA

We were founded in Taiwan in 1981. Ever since our establishment, we have been pursuing the goal to reach the highest standard to meet the demands for our customers. We specialize in R&D of brake systems and manufacturing and our featuring products are Hydraulic brakes, Fully hydraulic Rim Brake, Mechanical Disc Brake. We also have a wide selection of other products and accessories that are needed for the bike rides.

To reach the standard of ISO 9001 is our everlasting goal and after 33 years of hard work and efforts, we have gained customers throughout the world and now we are also looking for distributors to join us.

We have a group of well- trained and energetic staff who devote themselves wholeheartedly in our production line in order to bring out the best work to satisfy our customers.

We take part in cycle shows and activities like Taipei Cycle Show and Eurobike etc. to learn the needs of our customers and from this kind of participation has enabled us to gain more inspiration to improve ourselves.

As you can see,from the past to now we HAVE BEEN and WILL KEEP upgrading ourselves and continuously provide you the best quality products to suit your needs.

Ride with safety, ride with ALHONGA!

DISC

- 06 Hydraulic Disc Brake
- 08 Hydraulic Hose Replacement Kits
- 10 Mechanical Disc Brake
- 12 Disc Rotor
- 14 Adaptor/Brake Mounts

BRAKE & LEVER

- 16 V-Brake
- 21 U-Brake
- 22 Cantilever Brake
- 23 Caliper Brake
- 28 Brake Lever

PADS

- 38 Disc Pads
- 44 Brake Pads

ACCESSORIES

- 48 Accessories
- 54 Cycle Light Connector
- 54 Center-Lock Adaptor
- 55 Spacer & Seat Clamp
- 56 Chain Catcher
- 57 Pully
- 58 Inner Cable
- 60 Outer Casing
- 62 Universal Brake Group Set
- 63 Universal Shift Group Set

Compatibility



Designed for mountain bicycles.



Designed for trekking bicycles.



To work just about any bicycles.



Designed for BMX bicycles.



Designed for junior bicycle from 16 inches all the way up to 24 inches.



Designed specifically for cycle cross bicycles.



Designed for road bicycles.



Designed for beach cruiser bicycles.



Designed for folding bicycles.



Designed for city bicycles.



Designed for kid's bicycle from 12 inches all the way up to 16 inches.



Designed specifically for triathlon/time trial bicycles.

Cable Ends



Shimano®/SRAM® shift cable head on one end, Campagnolo shift cable head on the other.



Shimano®/SRAM® road brake cable head on one end and MTB brake head on the other

Component Compatibility & Tech



The Arm's length of V-brake.

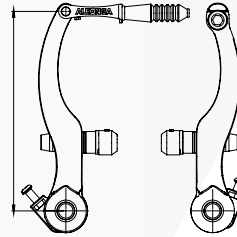

The fingers fitting of brake lever.

Brake Pad Type

Organic



Organic



ALL weather

Organic compound is specially formulated to produce excellent all around performance, perfect for everyday use.

Sinter



Sinter



Harsh weather

Sintered compound is designed to produce consistent performance in all condition, offer high durability and high resistance to contamination by mud, water, sand and grit.



ROAD
BRAKE

Compatible with braking systems on road brake.



CALIPER
BRAKE

Compatible with braking systems on caliper brake.



V-BRAKE

Compatible with braking systems on V-brake.



CANTILEVER
BRAKE

Compatible with braking systems on cantilever brake.

HYDRAULIC DISC BRAKE

A high efficiency aluminum-alloy hydraulic disc brake designed for mountain bikes and suitable for different roads and weather conditions. International standard and easy to install. Automatic oil-filling, heat-resistant and easy to adjust. A high efficiency Hose and a high performance on the low temperature pressure-resistance.



Display Box / No. KC-D01
Contains: 1 Set



HJ-OD03



HJ-OD04



HJ-OD05

HJ-OD03

System

Open system
Dual piston hydraulic disc brake
Non-corrosive mineral oil
Weight :
Front 342g (caliper+lever) / wheel
Rear 359g (caliper+lever) / wheel

HJ-OD04

Open system
Dual piston hydraulic disc brake
Non-corrosive mineral oil
Weight :
Front 340g (caliper+lever) / wheel
Rear 359g (caliper+lever) / wheel

HJ-OD05

Open system
Dual piston hydraulic disc brake
Non-corrosive mineral oil
Weight :
Front 322g (caliper+lever) / wheel
Rear 340g (caliper+lever) / wheel

Rotor

HJ-DXR1606
Diameter : 160mm (F/R)

HJ-DXR1606
Diameter : 160mm (F/R)

HJ-DXR1606
Diameter : 160mm (F/R)

Caliper

Forged alloy body
Automatic caliper positioning via adapters
front and rear Pad : High performance
metal ceramic compound HJ-DS17
(compatible Shimano)

Forged alloy body
Automatic caliper positioning via adapters
front and rear Pad : High performance
metal ceramic compound HJ-DS10
(compatible Shimano)

Forged alloy body
Automatic caliper positioning via adapters
front and rear Pad : High performance
metal ceramic compound HJ-DS10
(compatible Shimano)

Lever

Forged alloy body
2-Fingers design

Forged alloy body
2-Fingers design

Melt-forged alloy body
3-Fingers design

HYDRAULIC DISC BRAKE

OD04

OD03



OD05



HYDRAULIC HOSE REPLACEMENT KITS











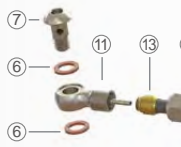

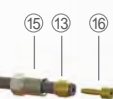
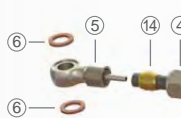
We provide a complete replacement kit with all the components required for popular brakes like Avid®, Shimano®, Formula®, Hope®, Hayes®, Magura® and so on. A godsend kit that includes enough hardware for one bicycle.

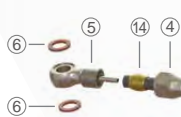

Blister Card / No.KC-B04
Contains: 1 Set

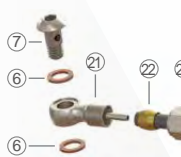
Part-No.	Caliper Side	Lever Side	Contents	Compatible Models
HJ-HHR101			<ul style="list-style-type: none"> ① -RT092Z*2PCS ② -RT008Z*2PCS ③ -HA007Z*2PCS 	Shimano® / XTR 2007-2010 DEORE XT 2008-2011 DEORE LX 2005-2011 SLX 2009-2011 DEORE 2005-2011
HJ-HHR102			<ul style="list-style-type: none"> ① -RT009Z*1PCS ② -RT008Z*2PCS ③ -HA007Z*1PCS ④ -RT019Z*1PCS ⑤ -RT010Z*1PCS ⑥ -W3016Z*2PCS ⑦ -HA010Z*1PCS 	Shimano® / DEORE XT 2005-2007 XTR 2011 SAINT
HJ-HHR103			<ul style="list-style-type: none"> ② -RT008Z*2PCS ④ -RT019Z*2PCS ⑤ -RT010Z*2PCS ⑥ -W3016Z*4PCS ⑦ -HA010Z*2PCS 	Shimano® / XTR 2005-2006
HJ-HHR201			<ul style="list-style-type: none"> ⑧ -RT012Z*2PCS ⑨ -RT011Z*2PCS ⑩ -HA008Z*2PCS 	Avid® / JUICY 3/3.5 CODE CODE 5 CODE CR
HJ-HHR202			<ul style="list-style-type: none"> ④ -RT019Z*1PCS ⑥ -W3016Z*2PCS ⑧ -RT012Z*1PCS ⑨ -RT011Z*2PCS ⑩ -HA008Z*1PCS ⑪ -RT018Z*1PCS 	Avid® / JUICY 5/7 JUICY ULTIMATE
HJ-HHR203			<ul style="list-style-type: none"> ⑥ -W3016Z*1PCS ⑧ -RT012Z*2PCS ⑨ -RT011Z*2PCS ⑩ -HA008Z*2PCS ⑫ -HA011Z*1PCS 	Avid® / ELIXIR R ELIXIR CR ELIXIR 5/7/9

HYDRAULIC HOSE REPLACEMENT

Part-No.	Caliper Side	Lever Side	Contents	Compatible Models
HJ-HHR301			<ul style="list-style-type: none"> ④ -RT019Z*1PCS ⑥ -W3016Z*2PCS ⑦ -HA010Z*1PCS ⑪ -RT018Z*1PCS ⑬ -RT013Z*2PCS ⑮ -HA009B*1PCS ⑯ -RT014Z*1PCS 	Magura® / LOUISE FR
HJ-HHR302			<ul style="list-style-type: none"> ⑥ -W3016Z*1PCS ⑫ -HA011Z*1PCS ⑬ -RT013Z*2PCS ⑮ -HA009B*2PCS ⑯ -RT014Z*2PCS 	Magura® / LOUISE MARTA SL MARTA
HJ-HHR401			<ul style="list-style-type: none"> ④ -RT019Z*1PCS ⑤ -RT010Z*1PCS ⑥ -W3016Z*2PCS ⑭ -RT006Z*2PCS ⑰ -HA006B*1PCS ⑱ -RT007Z*1PCS 	Formula® / Mega R1 The One
HJ-HHR402			<ul style="list-style-type: none"> ④ -RT019Z*2PCS ⑤ -RT010Z*2PCS ⑥ -W3016Z*4PCS ⑭ -RT006Z*2PCS 	Formula® / B4 Oro K18 Oro K24 4 Racing XC
HJ-HHR501			<ul style="list-style-type: none"> ⑱ -RT005Z*2PCS ⑳ -RT002UP*2PCS 	Hayes® / STROKER RYDE STROKER DYNO Alhonga® / OD04
HJ-HHR502			<ul style="list-style-type: none"> ⑥ -W3016Z*2PCS ⑦ -HA010Z*1PCS ⑱ -RT005Z*1PCS ⑳ -RT002UP*1PCS ㉑ -RT017Z*1PCS ㉒ -RT015Z*1PCS ㉓ -RT016Z*1PCS 	Hayes® / STROKER TRAIL STROKER CARBON STROKER ACE STROKER GRAM EL CAMINO PRIME PRO PRIME EXPERT Alhonga® / OD03
HJ-HHR503			<ul style="list-style-type: none"> ⑥ -W3016Z*1PCS ⑫ -HA011Z*1PCS ⑱ -RT005Z*2PCS ⑳ -RT002UP*2PCS 	Hayes® / NINE

MECHANICAL DISC BRAKE

A high efficiency aluminum-alloy mechanical disc brake designed for mountain bikes and suitable for all road conditions. The enhancement on the brake power makes every brake without limitations. International standard and easy to install.



Display Box / No.KC-D16
Contains: 1 Set



HJ-MD11

System ball bearing system, adapter for "IS" mount
Control cable actuated
Caliper melt-forged aluminum
Pad HJ-DS10
Rotor stainless steel front/rear : 160mm HJ-DXR1604

Weight	250g/wheel
---------------	------------



HJ-MD15

System ball bearing system, adapter for "IS" mount
Control cable actuated
Caliper melt-forged aluminum
Pad HJ-DS26
Rotor stainless steel front/rear : 160mm HJ-DXR1604

Weight	225g/wheel
---------------	------------

MECHANICAL DISC BRAKE

HJ-MD11



HJ-MD15

DISC ROTOR

Standard rotors, 6 bolts. A very high quality heat-treated, durable and long-lasting construction. To enhance the efficiency, our products have gone through high-speed balance tests. We offer different colors and appearance options to suit your needs.



Skin Card / No.KC-S05
Contains: 1 Pcs

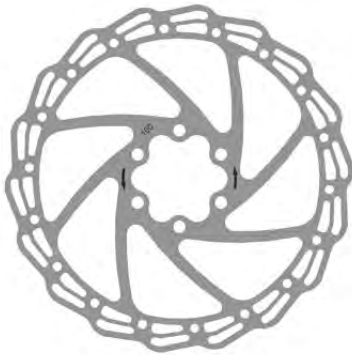

SILVER

• MATERIAL STAINLESS

Color \ Size	Ø140mm	Ø160mm	Ø180mm	Ø203mm
SILVER	HJ-DXR1406-SI	HJ-DXR1606-SI	HJ-DXR1806-SI	HJ-DXR2006-SI
BLACK	HJ-DXR1406-BK	HJ-DXR1606-BK	HJ-DXR1806-BK	HJ-DXR2006-BK
BLUE	HJ-DXR1406-BL	HJ-DXR1606-BL	HJ-DXR1806-BL	HJ-DXR2006-BL
RED	HJ-DXR1406-RD	HJ-DXR1606-RD	HJ-DXR1806-RD	HJ-DXR2006-RD
GOLD	HJ-DXR1406-GO	HJ-DXR1606-GO	HJ-DXR1806-GO	HJ-DXR2006-GO



BLACK



BLUE



RED



GOLD

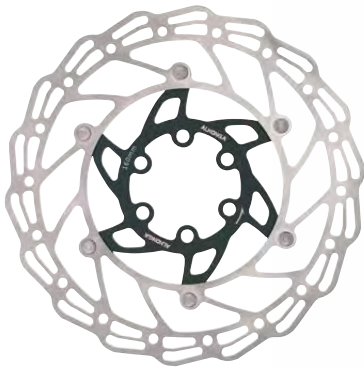

BLACK

• MATERIAL STAINLESS

Color \ Size	Ø140mm	Ø160mm	Ø180mm
BLACK	HJ-DXR1407-BK	HJ-DXR1607-BK	HJ-DXR1807-BK
BLUE	HJ-DXR1407-BL	HJ-DXR1607-BL	HJ-DXR1807-BL
RED	HJ-DXR1407-RD	HJ-DXR1607-RD	HJ-DXR1807-RD
GOLD	HJ-DXR1407-GO	HJ-DXR1607-GO	HJ-DXR1807-GO



BLUE



RED



GOLD

DISC ROTOR

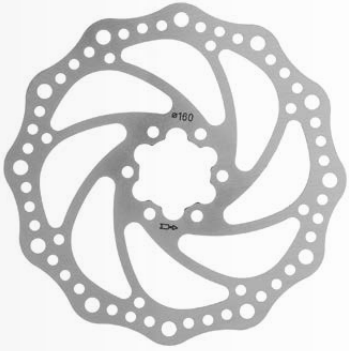

SILVER

• MATERIAL STAINLESS

Color	Size	Ø160mm
SILVER		HJ-DXR1604-SI
BLACK		HJ-DXR1604-BK
BLUE		HJ-DXR1604-BL
RED		HJ-DXR1604-RD
GOLD		HJ-DXR1604-GO



BLACK



BLUE



RED



GOLD



SILVER

• MATERIAL STAINLESS

Color	Size	Ø160mm
SILVER		HJ-DXR1603-SI
BLACK		HJ-DXR1603-BK
BLUE		HJ-DXR1603-BL
RED		HJ-DXR1603-RD
GOLD		HJ-DXR1603-GO



BLACK



BLUE



RED



GOLD



LIGHT

• MATERIAL STAINLESS

Color	Size	Ø160mm 80g
SILVER		HJ-W1523-SI
BLACK		HJ-W1523-BK
BLUE		HJ-W1523-BL
RED		HJ-W1523-RD
GOLD		HJ-W1523-GO

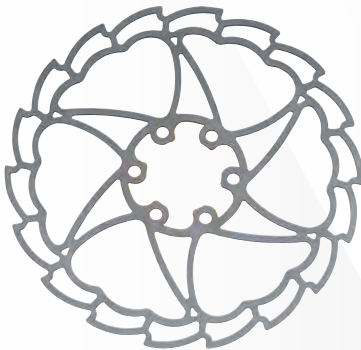

SILVER



BLACK



BLUE



RED



GOLD

ADAPTOR / Brake Mounts

Designed to match the front fork and the frame with an easy installment.
We offer a wide selection from 140mm to 203mm.



Skin Card / No.KC-S04
Contains: 1 Pcs



PI-F160



PI-F180 / R160



PI-F203 / R180



PI-R203



PP-F180-1



PP-F180-2



PP-F203



II-F180



II-F203

IS ↔ **PM** F160
International Standard Post mount

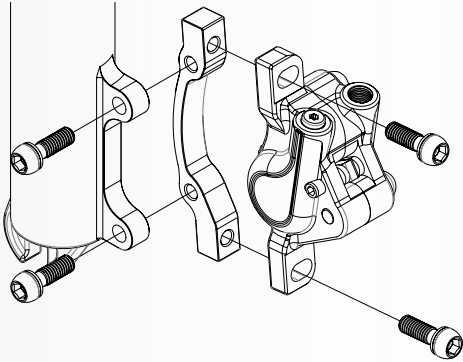

PM ↔ **PM** F203
Post mount Post mount

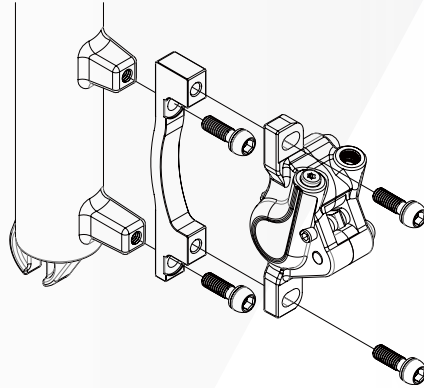

IS ↔ **IS** F180
International Standard

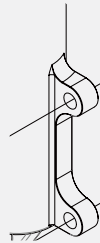
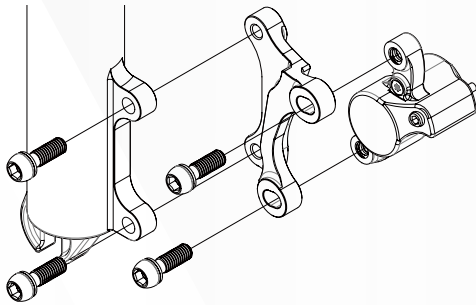

IS = International Standard

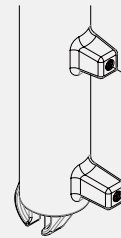

PM = Post mount

Part No.	Caliper	Fork	Frame	Rotor	QTY	Pack
PI-F160	PM	IS	-	160mm	1	Skin Card
PI-F180/R160	PM	-	IS	160mm	1	Skin Card
	PM	IS	-	180mm		
PI-F203/R180	PM	-	IS	180mm	1	Skin Card
	PM	IS	-	203mm		
PI-R203	PM	-	IS	203mm	1	Skin Card
PP-F180-1	PM	PM	-	180mm	1	Skin Card
PP-F180-2	PM	PM	-	180mm	1	Skin Card
PP-F203	PM	PM	-	203mm	1	Skin Card
II-F180	IS	IS	-	180mm	1	Skin Card
II-F203	IS	IS	-	203mm	1	Skin Card

V-BRAKE

A very high quality designed v-brake for all kinds of bikes. The improvements on its design makes it easy to maintain and allows the riders to ride effortlessly with joy and confidence.

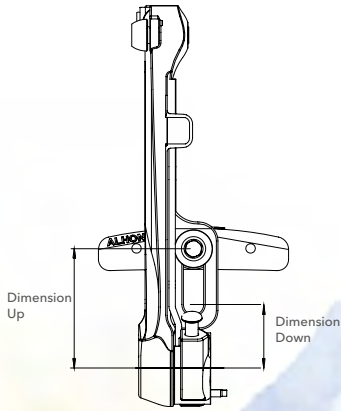

Display Box / No.KC-D05
Contains: 2 Wheels



Head Card / No.KC-H01
Contains: 2 Wheels

V-BRAKE





85
mm



FOLDING



BMX



JUNIOR



KID

HJ-623ADX

Arms melt-forged alloy

Spring system linear type

Dimension 20-38mm

Standard shoes 601.12 (60mm)

Guide pipe F/90° R/135°

Weight	180g/wheel
---------------	------------



95
mm



FOLDING



BMX



JUNIOR



KID

HJ-622AD7

Arms melt-forged alloy

Spring system linear type

Dimension 20-38mm

Standard shoes 601.12 (60mm)

Guide pipe F/90° R/135°

Weight	180g/wheel
---------------	------------



95
mm



FOLDING



BMX



JUNIOR



KID

HJ-7011AD7

Arms melt-forged alloy

Spring system linear type

Dimension 18-36mm

Standard shoes 601.12 (60mm)

Guide pipe F/90° R/135°

Weight	180g/wheel
---------------	------------



103
mm



HJ-612AD7

Arms melt-forged alloy
Spring system linear type
Dimension 20-38mm
Standard shoes HJ-601.12 (60mm)
Guide pipe F/90° R/135°

Weight 194g/wheel



103
mm



HJ-620A6

Arms forged alloy
Spring system linear type
Dimension 21-35mm
Standard shoes 600.12 (70mm)
Guide pipe F/90° R/135°

Weight 194g/wheel



103
mm



HJ-621ADX

Arms melt-forged alloy
Spring system linear type
Dimension 20-38mm
Standard shoes 601.12 (60mm)
Guide pipe F/90° R/135°

Weight 194g/wheel



102
mm



HJ-624AD

Arms melt-forged alloy
Spring system coil type
Dimension 20-38mm
Standard shoes 601.12 (60mm)
Guide pipe F/90° R/135°

Weight 183g/wheel



110
mm



MTB



CITY



TREKKING

HJ-605A6

Arms forged alloy
Spring system linear type
Dimension 18-38mm
Standard shoes 600.12 (70mm)
Guide pipe F/90° R/135°

Weight 168g/wheel



110
mm



MTB



CITY



TREKKING

HJ-721ADX

Arms melt-forged alloy
Spring system linear type
Dimension 22-39mm
Standard shoes 601.12 (60mm)
Guide pipe F/90° R/135°

Weight 181g/wheel



110
mm



MTB



CITY



TREKKING

HJ-725AD7

Arms melt-forged alloy
Spring system linear type
Dimension 20-38mm
Standard shoes 601.12 (60mm)
Guide pipe F/90° R/135°

Weight 196g/wheel



110
mm



MTB



CITY



TREKKING

HJ-732AD

Arms melt-forged alloy
Spring system coil type
Dimension 20-36mm
Standard shoes 601.12 (60mm)
Guide pipe F/90° R/135°

Weight 170g/wheel



HJ-811AD7

Arms melt-forged alloy
Spring system linear type
Dimension 20-38mm
Standard shoes 601.12 (60mm)
Guide pipe F/90° R/135°

Weight 180g/wheel



HJ-6021S7

Arms steel
Spring system linear type
Dimension 20-36mm
Standard shoes HJ-601.12 (60mm)
Guide pipe F/90° R/135°

Weight 186g/wheel



HJ-808PE

Arms resin with steel insert
Spring system coil type
Dimension 21-35mm
Standard shoes HJ-601.12 (60mm)
Guide pipe F/90° R/135°

Weight 177g/wheel



HJ-812AD7

Arms melt-forged alloy
Spring system linear type
Dimension 20-40mm
Standard shoes 601.12 (60mm)
Guide pipe F/90° R/135°

Weight 198g/wheel

U - BRAKE

A high quality U-BRAKE designed for BMX / FREE STYLE.
The improvements of the design makes it easy to maintain
and gives the rider a pleasant riding experience.



HJ-923ADU

Arms melt-forged alloy
Spring system coil type
Dimension 29-45mm
Standard shoes 601.12 (60mm)

Weight 176g/wheel



HJ-926ADU

Arms melt-forged alloy
Spring system coil type
Dimension 29-45mm
Standard shoes 601.12 (60mm)

Weight 180g/wheel



Thread removable
mount bolt



HJ-928ADU

Arms melt-forged alloy
Springhanger designed
Dimension 24-43mm
Standard shoes 601.12 (60mm)
Option : Thread removable mount bolt

Weight 180g/wheel

New Brake Concept
- The Hanger Offer Spring Function
With A Straightforward Looking & Simple!

CANTILEVER BRAKE

CANTILEVER BRAKE

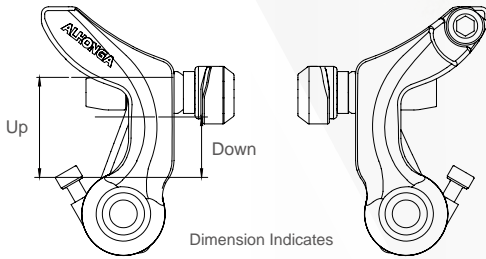

HJ-922AG

Arms forged alloy
 Spring system linear type
 Dimension 21-35mm
 Standard shoes 601.12 (60mm)

Weight 173g/wheel



HJ-924AD

Arms melt-forged alloy
 Spring system coil type
 Dimension 21-35mm
 Standard shoes 601.12 (60mm)

Weight 175g/wheel

CANTILEVER BRAKE

CALIPER BRAKE

Designed to match all kinds of bikes, very high quality and easy to maintain. Our CALIPER BRAKE enables every ride with control and confidence.



Display Box / No.KC-D11
Contains: 1 Bike



Head Card / No.KC-H01
Contains: 1 Bike

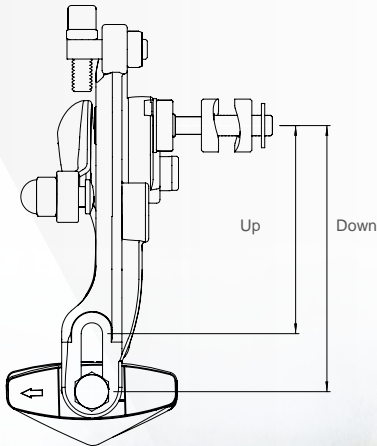

Dimension Indicates

CALIPER BRAKE





HJ-N401AQ3

Arms forged alloy
Power reinforcement with dual-pivot device
Dimension 39-49mm with quick release
Standard shoes 401.11A (adjustable angle)

Weight 184g/wheel



HJ-N402AQ3

Arms forged alloy
Power reinforcement with dual-pivot device
Dimension 43-57mm with quick release
Standard shoes 401.11A (adjustable angle)

Weight 190g/wheel



HJ-423AQ

Arms forged alloy
Power reinforcement with dual-pivot device
Dimension 39-49mm with quick release
Standard shoes 401.11A (adjustable angle)

Weight 190g/wheel



HJ-422ADQ

Arms melt-forged alloy
Power reinforcement with dual-pivot device
Dimension 47-59mm with quick release
Standard shoes 405.11 (Adjustable angle)

Weight 190g/wheel

CALIPER BRAKE



HJ-401AG2

Arms forged alloy
Power reinforcement with dual-pivot device
Dimension 39-49mm
Standard shoes 450.11

Weight	176g/wheel
---------------	------------



HJ-421ADQ

Arms melt-forged alloy
Power reinforcement with dual-pivot device
Dimension 39-49mm with quick release
Standard shoes 405.11 (adjustable angle)

Weight	180g/wheel
---------------	------------



HJ-402AG2

Arms forged alloy
Power reinforcement with dual-pivot device
Dimension 43-57mm
Standard shoes 450.11

Weight	196g/wheel
---------------	------------



FOLDING



CITY

HJ-N405AQ

Arms forged alloy

Power reinforcement with dual-pivot device

Dimension 54.5-76.5mm with quick release

Standard shoes 405.11 (adjustable angle)

Weight	184g/wheel
---------------	------------



FOLDING



CITY

HJ-714AG

Arms forged alloy

Power reinforcement with dual-pivot device

Dimension 57-75mm

Standard shoes 450.11

Weight	184g/wheel
---------------	------------



CITY



JUNIOR



KID

HJ-810A

Arms forged alloy

Central screw F/51mm R/31mm

Dimension 61-79mm

Weight	175g/wheel
---------------	------------



HJ-1000A

Arms forged alloy
Central screw F/51mm R/31mm
Dimension 73-91mm

Weight 170g/wheel



HJ-1000S

Arms steel
Central screw F/51mm R/31mm
Dimension 73-91mm

Weight 269g/wheel



HJ-1020A

Arms forged alloy
Central screw F/51mm R/31mm
Dimension 73-91mm

Weight 170g/wheel



HJ-1020S

Arms steel
Central screw F/51mm R/31mm
Dimension 73-91mm

Weight 269g/wheel

BRAKE LEVER

Designed for all kinds of brakes, ergonomic squeeze and easy to maintain. Plus they are easy to install and offer you a ride with pleasure.



Display Box / No.KC-D05
Contains: 1 Pair



Head Card / No.KC-H02
Contains: 1 Pair

BRAKE LEVER



HJ-261AG

Bracket / Lever super nylon composite /
forged alloy aero-lever return spring
Clamp diameter 22.2-23.8mm

Weight 248g/pair



HJ-272AQ

Bracket / Lever super nylon composite /
forged alloy aero-lever return spring with quick release
Clamp diameter 22.2-23.8mm

Weight 193g/pair



HJ-R263A

Bracket / Lever forged alloy for use with caliper or cantilever
brakes reach adjustment & return spring hinged bracket
Clamp diameter 22.2/23.8/28.6/31.8mm

Weight 104g/pair



HJ-R265A

Bracket melt-forged / Lever forged alloy
Aero bar ID Ø19.8 / Ø20.8

Weight 162g/pair

- For use with caliper or cantilever brakes
Internal cable position design





HJ-356AV

Bracket / Lever melt-forged alloy / forged alloy
 Compatible brake type direct-pull brakes
 Compatible shifter twist & thumb shifter

Weight 204g/pair



HJ-317PV



HJ-317PDV

Material : Bracket / Lever
 HJ-317PDV : Nylon composite / Melt-forged alloy
 HJ-317PV : Nylon composite / Resin with steel insert
 Compatible brake type direct-pull brakes
 Compatible shifter thumb shifter

Weight HJ-317PDV : 195g/pair
 HJ-317PV : 190g/pair



HJ-169PV

Bracket / Lever nylon composite
 Compatible brake type direct-pull brakes

Weight 124g/pair



HJ-290PDV



HJ-290ADV

Material : Bracket / Lever
 HJ-290ADV : Melt-forged alloy
 HJ-290PDV : Nylon composite / Melt-forged alloy
 Compatible brake type direct-pull brakes
 Compatible shifter twist & thumb shifter

Weight HJ-290ADV : 210g/pair
 HJ-290PDV : 203g/pair

BRAKE LEVER



HJ-327PDV

HJ-327PV



HJ-327ADV

Material : Bracket / Lever

HJ-327ADV : Melt-forged alloy

HJ-327PDV : Nylon composite / Melt-forged alloy

HJ-327PV : Nylon composite / Resin with steel insert

Compatible brake type direct-pull brakes

Compatible shifter revo & twist shifter

Weight

HJ-327ADV : 196g/pair

HJ-327PDV : 170g/pair

HJ-327PV : 164g/pair



HJ-340PDV

HJ-340PV



HJ-340ADV

Material : Bracket / Lever

HJ-340ADV : Melt-forged alloy

HJ-340PDV : Nylon composite / Melt-forged alloy

HJ-340PV : Nylon composite / Resin with steel insert

Compatible brake type direct-pull brakes

Compatible shifter twist & thumb shifter

Weight

HJ-340ADV : 200g/pair

HJ-340PDV : 185g/pair

HJ-340PV : 180g/pair



HJ-3022PDV



HJ-3022ADV

Material : Bracket / Lever

HJ-3022ADV : Melt-forged alloy

HJ-3022PDV : Nylon composite / Melt-forged alloy

Compatible brake type direct-pull brakes

Compatible shifter twist & thumb shifter

Weight

HJ-3022ADV : 215g/pair

HJ-3022PDV : 174g/pair



HJ-3030PDV



HJ-3030ADV

Material : Bracket / Lever

HJ-3030ADV : Melt-forged alloy

HJ-3030PDV : Nylon composite / Melt-forged alloy

Compatible brake type direct-pull brakes

Compatible shifter twist & thumb shifter

Weight

HJ-3030ADV : 175g/pair

HJ-3030PDV : 170g/pair



HJ-3032ADV

Bracket / Lever melt-forged alloy
 Compatible brake type direct-pull brakes
 Compatible shifter twist & thumb shifter

Weight 208g/pair



HJ-3033ADV

Bracket / Lever melt-forged alloy
 Compatible brake type direct-pull brakes
 Compatible shifter twist & thumb shifter

Weight 210g/pair



HJ-288ADV

Material : Bracket / Lever
 HJ-288ADV : Melt-forged alloy
 HJ-288PDV : Nylon composite / Melt-forged alloy
 HJ-288PV : Nylon composite / Resin with steel insert
 Compatible brake type direct-pull brakes
 Compatible shifter twist & thumb shifter

Weight
 HJ-288ADV : 189g/pair
 HJ-288PDV : 169g/pair
 HJ-288PV : 168g/pair



HJ-296ADV

Material : Bracket / Lever
 HJ-296ADV : Melt-forged alloy
 HJ-296PDV : Nylon composite / Melt-forged alloy
 Compatible brake type direct-pull brakes
 Compatible shifter twist & thumb shifter

Weight
 HJ-296ADV : 189g/pair
 HJ-296PDV : 171g/pair

BRAKE LEVER



HJ-170PDV

Bracket / Lever nylon composite / melt-forged alloy
 Compatible brake type direct-pull brakes
 Compatible shifter thumb shifter

Weight 142g/pair



HJ-342PV



HJ-342PDV

Material : Bracket / Lever
 HJ-342PDV : Nylon composite / Melt-forged alloy
 HJ-342PV : Nylon composite / Resin with steel insert
 Compatible brake type direct-pull brakes
 Compatible shifter twist & thumb shifter

Weight HJ-342PDV : 215g/pair
 HJ-342PV : 208g/pair



HJ-269PV

Bracket / Lever nylon composite
 / resin with steel insert
 Compatible brake type direct-pull brakes
 Compatible shifter twist & thumb shifter

Weight 192g/pair



HJ-N213ADV



HJ-213ADV

Bracket / Lever melt-forged alloy
 Compatible brake type direct-pull brakes
 Compatible shifter twist & thumb shifter

Weight 220g/pair



HJ-297PDV



HJ-297ADV

Bracket / Lever melt-forged alloy
 HJ-297ADV : Melt-forged alloy
 HJ-297PDV : Nylon composite / Melt-forged alloy
 Compatible brake type direct-pull brakes
 Compatible shifter twist & thumb shifter

Weight
 HJ-297ADV : 280g/pair
 HJ-297PDV : 210g/pair



HJ-3027PDV



HJ-3027ADV

Material : Bracket / Lever
 HJ-3027ADV : Melt-forged alloy
 HJ-3027PDV : Nylon composite / Melt-forged alloy
 Compatible brake type direct-pull brakes
 Compatible shifter twist & thumb shifter

Weight
 HJ-3027ADV : 212g/pair
 HJ-3027PDV : 208g/pair



HJ-3037ADV

Bracket / Lever melt-forged alloy
 Compatible brake type direct-pull brakes
 Compatible shifter twist & thumb shifter

Weight 280g/pair



HJ-3028PDV

Bracket / Lever nylon composite / melt-forged alloy
 Compatible brake type direct-pull brakes
 Compatible shifter Revo & Twist shifter

Weight 196g/pair



HJ-289PDV



HJ-289ADV

Material : Bracket / Lever
 HJ-289ADV : Melt-forged alloy
 HJ-289PDV : Nylon composite / Melt-forged alloy
 Compatible brake type direct-pull brakes
 Compatible shifter twist & thumb shifter

Weight	HJ-289ADV : 201g/pair
	HJ-289PDV : 184g/pair



HJ-3034PDV

Bracket / Lever nylon composite / melt-forged alloy
 Compatible brake type direct-pull brakes
 Compatible shifter Revo & Twist shifter

Weight	195g/pair
---------------	-----------



HJ-4120AD

Bracket / Lever melt-forged alloy
 Compatible brake type caliper or cantilever brakes
 Hinged bracket designed

Weight	185g/pair
---------------	-----------



HJ-4123PD



HJ-4123AD

Material : Bracket / Lever
 HJ-4123AD : Melt-forged alloy
 HJ-4123PD : Nylon composite / Melt-forged alloy
 Compatible brake type caliper or cantilever brakes

Weight	HJ-4123AD : 149g/pair
	HJ-4123PD : 142g/pair



HJ-303AD

Bracket / Lever melt-forged alloy
Compatible brake type caliper or cantilever brakes

Weight 158g/pair



HJ-3021PD

Bracket / Lever nylon composite / melt-forged alloy
Compatible brake type caliper or cantilever brakes

Weight 142g/pair



HJ-365AD

Bracket / Lever melt-forged alloy
Compatible brake type Caliper or Cantilever brakes

Weight 200g/pair



HJ-361P

Bracket / Lever nylon composite / resin with steel insert
Compatible brake type caliper or cantilever brake
Safety bracket design

Weight 192g/pair



HJ-129S

Bracket / Lever steel

Compatible brake type caliper or cantilever brake

Clamp diameter Ø 22.2mm

Weight 220g/pair



HJ-131A

Bracket / Lever forged alloy

Compatible brake type caliper or cantilever brake

Clamp diameter Ø 22.2mm

Weight 198g/pair



HJ-144A

Bracket / Lever forged alloy

Compatible brake type caliper or cantilever brake

Clamp diameter Ø 22.2 - 23.8mm

Weight 198g/pair



HJ-165A

Bracket / Lever forged alloy

Compatible brake type caliper or cantilever brake

With safety alloy lever

Clamp diameter Ø 22.2 - 23.8mm

Weight 270g/pair

DISC PADS

We offer a wide selection of disc pads for different brands and materials. Designed for any weather and rough conditions for the riders to ride with comfort and safety.



Blister Card / No.KC-B03
Contains: 1 Pair

Organic



Organic



ALL weather

Organic compound is specially formulated to produce excellent all around performance, perfect for everyday use.

Sinter



Sinter



Harsh weather

Sintered compound is designed to produce consistent performance in all condition, offer high durability and high resistance to contamination by mud, water, sand and grit.















DISC PADS

ALHONGA®

Part No.	Compatible Brand	Compound
HJ-DS10	HJ-OD04	 Organic
HJ-DS10S	HJ-OD05	 Sinter
HJ-DS17	HJ-OD03	 Organic
HJ-DS17S		 Sinter
HJ-DS23	Mechanical disc brake 7002A	 Organic

Avid®

Part No.	Compatible Brand	Compound
HJ-DS11	Juicy and ball-bearing mechanical calipers	 Organic
HJ-DS11S		 Sinter
HJ-DS34	Code	 Organic
HJ-DS34S		 Sinter
HJ-DS38	BB5	 Organic
HJ-DS44	Elixir	 Organic
HJ-DS44S		 Sinter
HJ-DS53	CODE 2011	 Organic
HJ-DS53S		 Sinter
HJ-DS57	XO TRAIL	 Organic
HJ-DS57S		 Sinter
HJ-DS60	DB1/DB3/DB5 hydraulic	 Organic

Diatech®

Part No.	Compatible Brand	Compound
HJ-DS32	Anchor	 Organic
HJ-DS32S		













Formula®

Part No.	Compatible Brand	Compound
HJ-DS16	B4 Team / Pro / SL & 4 Racing caliper	 Organic
HJ-DS16S		 Sinter
HJ-DS31	Oro calipers	 Organic
HJ-DS31S		 Sinter
HJ-DS42	Maga One	 Organic
HJ-DS42S		 Sinter

Giant®





















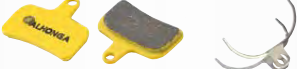

Part No.	Compatible Brand	Compound
HJ-DS21	Giant MPH 2001-2005	 Organic

Hayes®

Part No.	Compatible Brand	Compound
HJ-DS01	Hydraulic and Mechanical	 Organic
HJ-DS01S		 Sinter
HJ-DS26	So1e / MX1 / MX2	 Organic
HJ-DS26S		 Sinter
HJ-DS37	EL Camino calipers	 Organic
HJ-DS37S		 Sinter
HJ-DS40	Stroker Ryde	 Organic
HJ-DS40S		 Sinter
HJ-DS41	Stroker Trial	 Organic
HJ-DS41S		 Sinter
HJ-DS45	Ace	 Organic
HJ-DS45S		 Sinter
HJ-DS49	Prime	 Organic

DISC PADS

Hope®

Part No.		Compatible Brand	Compound
HJ-DS05		Open / Closed 2-piston calipers Pro / Sport	 Organic
HJ-DS09		Mono M4 calipers	 Organic
HJ-DS09S			 Sinter
HJ-DS20		Mini calipers	 Organic
HJ-DS22		M4 / Organic / DH4 calipers, pack of 2 pairs	 Organic
HJ-DS24		XC4 calipers	 Organic
HJ-DS28		Mono 6-pot calipers	 Organic
HJ-DS29		Mono Mini caliper	 Organic
HJ-DS35		Moto V2	 Organic
HJ-DS39		Mono Trial	 Organic
HJ-DS48		X2	 Organic
HJ-DS58		V4	 Organic

Joytec®











Part No.		Compatible Brand	Compound
HJ-DS47		Joytec	 Organic

Logan®

Part No.	Compatible Brand	Compound
HJ-DS25S	Mechanical	 Organic



Magura®

Part No.	Compatible Brand	Compound
HJ-DS04	Clara 2000 / Louise 98-01 calipers	 Organic
HJ-DS12	Julie calipers	 Organic
HJ-DS14	Clara 2001-2 / Louise 2002 / Louise FR calipers	 Organic
HJ-DS19	Marta / SL calipers	 Organic
HJ-DS36	Louise 2007, Louise Carbon 2008	 Organic
HJ-DS55	MT2.4.6.8	 Organic
HJ-DS61	MT5	 Organic
HJ-DS61S		 Sinter
HJ-DS62	MT7, pack of 2 pairs	 Organic
HJ-DS62S		 Sinter
HJ-DS18	Gustav M calipers	 Organic



Promax®

Part No.	Compatible Brand	Compound
HJ-DS30	DSK-400 / DSK-601 / J&X NINE	 Organic













DISC PADS



Tektro®

Part No.	Compatible Brand	Compound
HJ-DS08	Mechanical calipers	 Organic
HJ-DS46	IOX	 Organic
HJ-DS56	LYRA / LOX	 Organic
HJ-DS59	Dorado (HD-E710)	 Organic

Shimano®

Part No.	Compatible Brand	Compound
HJ-DS09	XT M755 / 756 / Grimeca system 8.0+12	 Organic
HJ-DS09S		 Sinter
HJ-DS10	Deore M515 / M475 / C501 / C601 Mechanical / M525 hydraulic calipers	 Organic
HJ-DS10S		 Sinter
HJ-DS15	Deore M555 / Hydraulic / C900 / 901 Nexave calipers	 Organic
HJ-DS17	XTR M965 / 966 / Saint M800 / Hone M601 / Deore XT M765 / LX M585 calipers	 Organic
HJ-DS17S		 Sinter
HJ-DS43	Saint	 Organic
HJ-DS43S		 Sinter
HJ-DS52	XTR2011	 Organic
HJ-DS52S		 Sinter

SRAM®

Part No.	Compatible Brand	Compound
HJ-DS09	9.0	 Organic
HJ-DS09S		 Sinter
HJ-DS54	RED	 Organic

Suntour®

Part No.	Compatible Brand	Compound
HJ-DS27	DB XCC	 Organic























BRAKE PADS

Designed for all kinds of brakes.
PAD compound specially chosen for any weather conditions.

Skin Card / No.KC-S03
Contains: 1 Pair



FOR V-BRAKE

Part No.		Length	Pad color		Compatible
HJ-ABS-01VC	 	72mm	Black Orange	Silver alloy-pad holder	
HJ-ABS-01VCR	For replacement				
HJ-739.13A		72mm	Black	Silver alloy-pad holder	
HJ-739.13AR	For replacement				
HJ-741.13A		72mm	Black	Silver alloy-pad holder	
HJ-741.13AR	For replacement				
HJ-741.13A3		72mm	Triple color	Silver alloy-pad holder	
HJ-741.13A3R	For replacement				
HJ-742.13A3		72mm	Triple color	Black alloy-pad holder	
HJ-742.13A3R	For replacement				
HJ-748.13A		72mm	Triple color	Black alloy-pad holder	
HJ-748.13AR	For replacement				
HJ-749.13A		72mm	Gray	Carbon look alloy-pad holder	
HJ-749.13AR	For replacement				
HJ-748.13T3		72mm	Triple color		
HJ-742.13T3		72mm	Triple color		
HJ-BX753		72mm	Black/Red		
HJ-EN01		60mm	Black		

BRAKE PADS

















Part No.		Length	Pad color		Compatible
HJ-EN02-OR		60mm	Orange		
HJ-EN02-RD			Red		
HJ-EN02-BL			Blue		
HJ-EN02-GR			Green		
HJ-601.12T3		60mm	Black		
HJ-602.12T3-BK		60mm	Black hardware		
HJ-602.12T3-PU			Purple hardware		
HJ-602.12T3-RD			Red hardware		
HJ-602.12T3-GO			Gold hardware		
HJ-602.12T3-BL	Blue hardware				
HJ-603.13T3		60mm	Black		
HJ-600.12T3		70mm	Black		
HJ-600.12T3G2		70mm	Black/Yellow		
HJ-741.13		72mm	Black		
HJ-741.13T3		72mm	Triple color		
HJ-BX754 (Adjustable angle)		72mm	Black		
HJ-609.12T3		70mm	Black		
HJ-739.13T3		72mm	Black		

FOR V-BRAKE

Part No.		Length	Pad color	Compatible
HJ-959.13T2		72mm	Black/Red	
HJ-600.12T2		70mm	Black	
HJ-600.12T2G2		72mm	Black/Yellow	

FOR ROAD BRAKE















Part No.		Length	Pad color	Compatible
HJ-ABS-01RC (Adjustable angle)	 	55mm	Silver alloy-pad holder	
HJ-ABS-01RCR			Black/Orange For replacement	
HJ-401.11A (Adjustable angle)		53mm	Silver alloy-pad holder	
HJ-401.11AR			Black For replacement	
HJ-452.11A		53mm	Silver alloy-pad holder	
HJ-452.11AR			Black For replacement	
HJ-BX480A (Adjustable angle)		55mm	Triple color Silver alloy-pad holder	
HJ-BX483A (Adjustable angle)		55mm	Triple color Black alloy - Pad holder	
HJ-405.11-BK	 (Adjustable angle)	50mm	Black	
HJ-405.11-GR			Green	
HJ-405.11-PK			Pink	
HJ-405.11-GO			Yellow	
HJ-405.11-RD			Red	
HJ-405.11-BL			Blue	
HJ-405.11-WH			White	
HJ-406.11 (Adjustable angle)				

BRAKE PADS

FOR ROAD BRAKE

Part No..		Length	Pad color	Compatible
HJ-450.11		50mm	Black	
HJ-451		50mm	Black	
HJ-457		50mm	Black	

FOR CALIPER BRAKE

Part No.		Length	Pad color	Compatible
HJ-BX250		40mm (5°)	Black/4-Colors	
HJ-203M		40mm (5°) Steel-pad holder	Black	
HJ-207M		40mm (0°) Steel-pad holder	Black	
HJ-211M		40mm (5°) Steel-pad holder	Black	
HJ-MX500		45mm (0°)	Black	
HJ-232		54mm (0°)	Black	
HJ-232N		54mm (0°)	Black	

FOR CANTILEVER BRAKE

Part No.		Length	Pad color	Compatible
HJ-902.11		55mm	Black	
HJ-900.13		60mm	Black	
HJ-902.13		70mm	Black	

ACCESSORIES

We provide a wide selection of components to suit your needs for the ride. It is very important to choose the right components to enhance your bike efficiency.



Blister Card / No.KC-B04



Skin Card / No.KC-S04



Bottle / No.KC-P03



ACCESSORIES



ARC WASHER

Model		Description	Material	Color
HJ-56A HJ-56S	 R 14.5	3mm Arc washer	Alloy Steel	Silver
HJ-58A HJ-58S	 R 6	3mm Arc washer	Alloy Steel	Silver







PLAT WASHER

Model		Description	Material	Color
HJ-W301A		3mm Plat washer	Alloy	Silver
HJ-W302A		5mm Plat washer	Alloy	Silver



ADJUSTING BARRELS FOR CALIPER

Model		Description	Material	Color
HJ-65A		M6 Adjusting barrels	Alloy	Silver
HJ-65S		M6 Adjusting barrels	Steel	Silver
HJ-H5233		M6 Adjusting barrels	Alloy	Silver
HJ-H5232		M6 Adjusting barrels	Alloy	Silver





ANCHOR BOLTS

Model		Description	Material	Color
HJ-64A		M5 Anchor bolt	Steel	Silver
HJ-64S		M6 Anchor bolt	Steel	Silver
HJ-70S		M6 Anchor bolt with open nut	Steel	Silver
HJ-70S1		M6 Anchor bolt with dome nut	Steel	Silver
HJ-70A		M5 Anchor bolt with dome nut	Steel	Steel
HJ-70A1		M5 Anchor bolt with open nut	Steel	Silver













CENTER BOLT FOR CALIPER

Model	Description	Material	Color
HJ-D40F	 51mm Anchor bolts	Steel	Silver
HJ-D42R	 31mm Anchor bolts	Steel	Silver

ADJUSTERS

Model	Description	Material	Color
HJ-68A	 M5 Index Adjusting barrels	Rubber coated / Alloy	Black /Silver
HJ-68S	 M5 Index Adjusting barrels	Rubber coated / Steel	Black /Silver
HJ-69A	 M5 Index Adjusting barrels	Rubber coated / Alloy	Black
HJ-LA01	 Inline Adjusters	Rubber coated / Alloy	Black





GUIDE PIPES

Model	Description	Material	Color	
HJ-600A.1 HJ-600S.1	 Ø6.1mm Option Ø5.1mm 90° / 110° / 135°	Stainless Steel	Silver	
HJ-601A.1	 Free angle Ø6.1mm	Stainless	Silver	
HJ-600A.1G	 Ø6.1mm 90° / 110° / 135°	Stainless	Black / Red / Blue	
HJ-601A.1G	 Free angle Ø6.1mm	Stainless	Black	
HJ-602A.1G	 Ø6.1mm 90° / 110° / 135°	Stainless	Black	
HJ-603A.1G	 Ø6.1mm 90° / 110° / 135°	Stainless	Black Silver	
HJ-605A.1G-BK	 Free angle Ø6.1mm	Stainless	Black	
HJ-605A.1G-RD			Red	
HJ-605A.1G-BL			Blue	
HJ-605A.1G-GR			Green	
HJ-605A.1G-GO			Gold	



CABLE PROTECTOR

Model		Description	Material	Color
HJ-600A.7		Cable protector 50mm	Rubber	Black
HJ-600A.9		Cable protector 37mm	Rubber	Black
HJ-607A.8		Cable protector 35mm	Rubber	Black

YOKE CABLES

Model		Description	Material	Color
HJ-DC508		Yoke cables 250mm	Steel	Black
HJ-DC525		Yoke cables 500mm	Steel	Black
HJ-DC532 HJ-DC533 HJ-DC534 HJ-DC535 HJ-DC536		73mm 82mm 84mm 93mm 106mm	Plastic/Steel	Gray
HJ-DC524		Yoke cables 380mm	Steel	Silver
HJ-DC538		Yoke cables 380mm	Steel	Silver

STRADDLE CABLE CARRIERS FOR CANTILEVER BRAKE

Model		Description	Material	Color
HJ-1242S2		Straddle cable carriers	Steel	Silver
HJ-1242A3		Straddle cable carriers	Alloy	Black
HJ-1242S3		Straddle cable carriers	Steel	Black









CABLE HANGER

Model	Description	Material	Color
HJ-1253	 Ø25.6mm	Steel	Black













NOSED END CAPS FOR HOUSING

Model	Description	Material	Color
HJ-PX002	 Cable end Ø5mm, fit 5mm outer cables	Alloy	Black

FRAME PROTECTORS

Model	Description	Material	Color
HJ-PX006	 Brake or Shift Housing Slide Type	Silicon	Black
HJ-PX007	 Brake or Shift Housing Clamp Type	Silicon	Black
HJ-PX008-BK	 Brake of Shift Housing	Silicon	Black 
HJ-PX008-BL			Blue 
HJ-PX008-RD			Red 
HJ-PX008-GR			Green 
HJ-PX008-GO			Yellow 
HJ-PX008-WH			White 
HJ-PX008-TP			Transparent 

CABLE ENDS FOR HOUSING

Model	Description	Material	Color
HJ-PX004-BK		Alloy	Black 
HJ-PX004-SI			Silver 
HJ-PX004-GO			Gold 
HJ-PX004-BL			Blue 
HJ-PX004-RD			Red 
HJ-D90			 Ø5mm, fits 5mm outer cables Option HJ-D90-1 Ø4mm
HJ-D92N	 Ø5mm, fits 5mm outer cables Option HJ-D92N4 Ø4mm	Brass by CNC	Chrome
HJ-D92	 Ø5mm, fits 5mm outer cables	Steel	Chrome
HJ-D92P	 Ø4mm, fits 4mm outer cables	Plastic	Black
HJ-D93P	 Ø5mm, fits 5mm outer cables	Plastic	Black
HJ-D95	 End Buttons	Alloy	Silver

CABLE ENDS FOR WIRE

Model	Description	Material	Color
HJ-D100		Alloy	Black
			Blue
			Gold
			Green
			Orange
			Red
HJ-D1001		Alloy	Black
			Blue
			Gold
			Green
			Orange
			Red

O-RINGS FOR WIRE

Model	Description	Material	Color
HJ-P706	O-ring Ø1.2mm, fits 1.2mm inner cables	TPR Rubber	Black
HJ-P7061	O-ring Ø1.5mm, fits 1.5mm inner cables	TPR Rubber	Black
HJ-P707	O-ring Ø1.2mm, fits 1.2mm inner cables	TPR Rubber	Transparent
HJ-P7071	O-ring Ø1.5mm, fits 1.5mm inner cables	TPR Rubber	Transparent

ADJUSTING BARRELS FOR LEVER

Model	Description	Material	Color
HJ-H520	Adjusting barrels M7	Alloy	Silver
HJ-H5021	Adjusting barrels M7	Alloy	Silver
HJ-H5396	Adjusting barrels M10	Alloy	Silver
HJ-H53921	Adjusting barrels M10	Alloy	Silver

CABLE CROSS

Model	Description	Material	Color
HJ-1503	Ø28.6mm	Steel	Silver
HJ-D106		Plastic	Black

CYCLE LIGHT CONNECTOR

EL01



- Available for DISC brake / V-Brake system
- CNC Machning parts
- Color : Red / Gold / Blue
- Weight : 133 g/wheel
- Pack : 1 Set/Blister Card

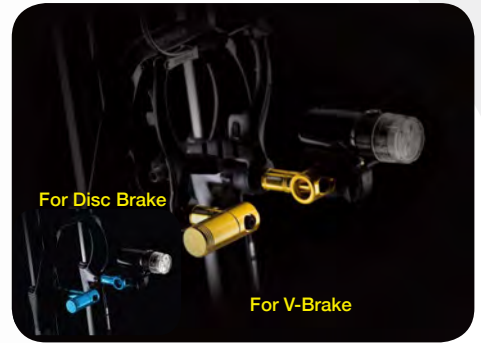
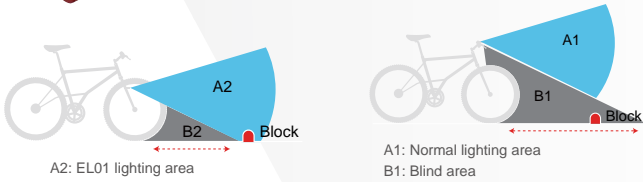

CENTER-LOCK ADAPTOR

Model	Color
HJ-ADR01	Silver

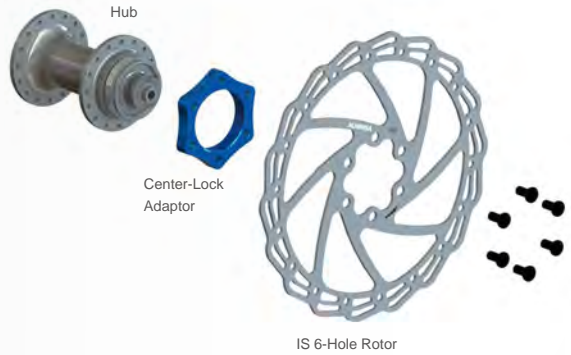

Model	Color
HJ-ADR02-BK	Black
HJ-ADR02-SI	Silver
HJ-ADR02-GO	Gold
HJ-ADR02-BL	Blue
HJ-ADR02-RD	Red

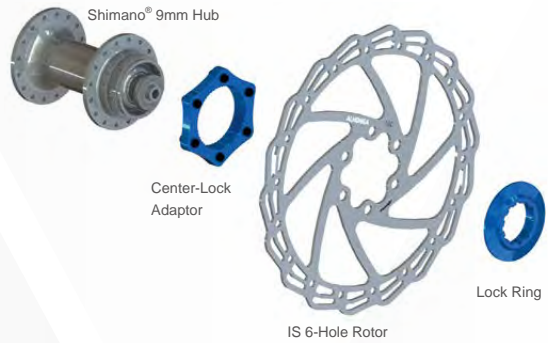

Model	Color
ADR03-BK	Black
ADR03-SI	Silver
ADR03-GO	Gold
ADR03-BL	Blue
ADR03-RD	Red

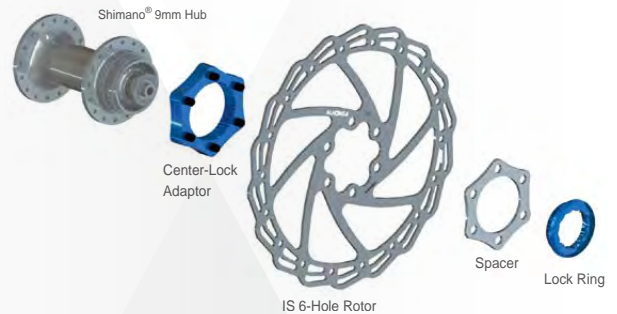

ACCESSORIES







SPACER

Model	Description	Material	Color
HJ-AL001	25.6mm	AL 6061T6	Black
	Length: 5/10/15/20 mm		
	28.8mm		
HJ-AL007	25.6mm	AL 6061T6	Black
	Length: 5/10/15/20 mm		
	28.8mm		
HJ-AL003	25.6mm	3K carbon fiber	Carbon
	Length: 5/10/15/20 mm		
	28.8mm		
	Length: 5/10/15/20 mm		

SEAT CLAMP

Model	Description	Material	Color
HJ-C056A	28.6mm	AL 6061T6	Black
	31.8mm		
	34.9mm		
HJ-C071A	31.8mm	AL 7075T6 Full CNC	Black
	34.9mm		
HJ-C075A	31.8mm	AL 7075T6 Full CNC	Black
	34.9mm		
HJ-C079A1	27.2+31.8mm	AL 6061T6 Full CNC	Black
	31.8+34.9mm		
HJ-C080A	34.9mm	AL 6061T6	Black
HJ-C095B	28.6mm	AL 6061T6	Black
	31.8mm		
	34.9mm		
HJ-C205	28.6mm	AL 6061T6	Black
	31.8mm		
	34.9mm		
HJ-C206	28.6mm	AL 6061T6	Black
	31.8mm		
	34.9mm		
HJ-C300	28.6mm	AL 6061T6	Black
	31.8mm		
	34.9mm		
HJ-C301	31.8mm	AL 6061T6	Black
	34.9mm		

SEAT CLAMP

Model		Description	Material	Color
HJ-C302		31.8mm	AL 6061T6	Black
		34.9mm		
HJ-C310		28.6mm	AL 6061T6	Black
		31.8mm		
		34.9mm		
HJ-C501		28.6mm	AL 6061T6	Black
		31.8mm		
		34.9mm		
HJ-C600		28.6mm	AL 6061T6	Black
		31.8mm		
		34.9mm		
HJ-C610		28.6mm	AL 6061T6	Black
		31.8mm		
		34.9mm		
HJ-C719		28.6mm	AL 6061T6	Black
		31.8mm		
		34.9mm		

CHAIN CATCHER

Model		Description	Color
HJ-FTP01-BK		100mm Bolt: 20mm/25mm	Black ●
HJ-FTP01-RD			Red ●
HJ-FTP01-BL			Blue ●
HJ-FTP01-GO			Gold ●
HJ-FTP02-BK			Black ●
HJ-FTP02-RD		31.8mm	Red ●
HJ-FTP02-BL			Blue ●
HJ-FTP02-GO			Gold ●
HJ-FTP021-BK			Black ●
HJ-FTP021-RD			Red ●
HJ-FTP021-BL		34.9mm	Blue ●
HJ-FTP021-GO			Gold ●







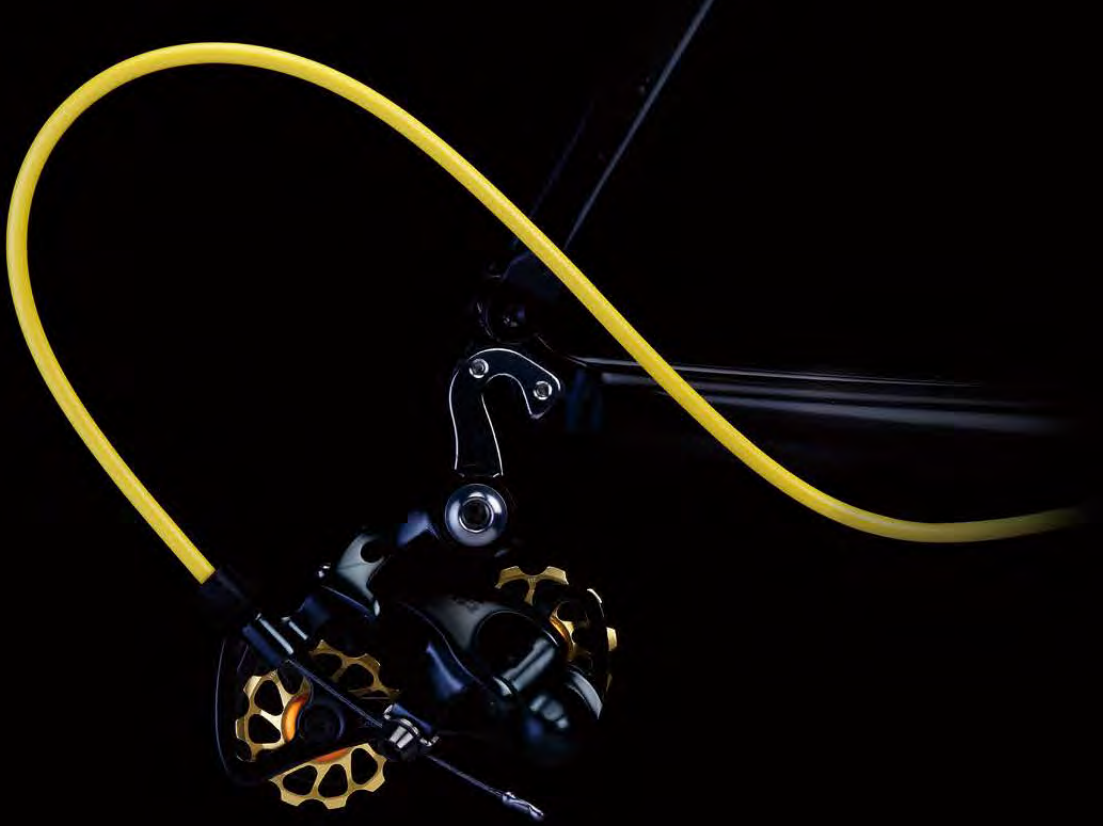











Chain catcher for racing bike





PULLY

Model	Description	Color
HJ-RD12-BK	11T 7075T6 CNC	Black 
HJ-RD12-RD		Red 
HJ-RD12-BL		Blue 
HJ-RD12-GO		Gold 
HJ-RD13-BK	11T 7075T6 CNC	Black 
HJ-RD13-RD		Red 
HJ-RD13-BL		Blue 
HJ-RD13-GO		Gold 
HJ-RD17-BK	11T 7075T6 CNC	Black 
HJ-RD17-RD		Red 
HJ-RD17-BL		Blue 
HJ-RD17-GO		Gold 
HJ-RD18-BK	11T 7075T6 CNC	Black 
HJ-RD18-RD		Red 
HJ-RD18-BL		Blue 
HJ-RD18-GO		Gold 

INNER CABLE DERAILLEUR & BRAKE

With a high quality manufacturing process, we offer a high quality cable that has an outstanding resistance for the pull and an excellent performance of the shift. Low friction modulus of PTFE inner cable keeps the rust off after a long time using.



Display Card / No.KC-L01
Contains: 1Pcs



Display Box / No.KC-D02
Contains: 100Pcs



Display Box / No.KC-D03
Contains: 50Pcs

Cable Ends

Derailleur

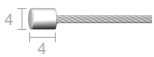

Brake



ROAD

MTB

MATERIALS



BASIC

- B1: Galvanized Steel
- B2: Stainless Steel

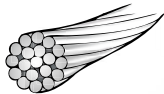

SLICK

- S1: Slick Galvanized Steel
- S2: Slick Stainless Steel

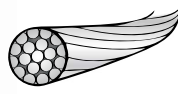





































PTFE













- C1: PTFE Slick Galvanized Steel
- C2: PTFE Slick Stainless Steel















Derailleur Inner

Model	Materials	Description	QTY	Pack
HJ-DWB1		  (4*4) 1.2*2300mm	1	KC-L01
HJ-DWB1-S	B1 Galvanized Steel	  (4*4) 1.2*2300mm	50	KC-D03
HJ-DWB1-B		  (4*4) 1.2*2300mm	100	KC-D02
HJ-DWB2		  (4*4) 1.2*2300mm	1	KC-L01
HJ-DWB2-S	B2 Stainless Steel	  (4*4) 1.2*2300mm	50	KC-D03
HJ-DWB2-B		  (4*4) 1.2*2300mm	100	KC-D02
HJ-DWS1		  (4*4) 1.2*2300mm	1	KC-L01
HJ-DWS1-S	S1 Slick Galvanized Steel	  (4*4) 1.2*2300mm	50	KC-D03
HJ-DWS1-B		  (4*4) 1.2*2300mm	100	KC-D02
HJ-DWS2		  (4*4) 1.2*2300mm	1	KC-L01
HJ-DWS2-S	S2 Slick Stainless Steel	  (4*4) 1.2*2300mm	50	KC-D03
HJ-DWS2-B		  (4*4) 1.2*2300mm	100	KC-D02
HJ-DWC1		  (4*4) 1.2*2300mm	1	KC-L01
HJ-DWC1-S	C1 Teflon Slick Galvanized Steel	  (4*4) 1.2*2300mm	50	KC-D03
HJ-DWC1-B		  (4*4) 1.2*2300mm	100	KC-D02
HJ-DWC2		  (4*4) 1.2*2300mm	1	KC-L01
HJ-DWC2-S	C2 Teflon Slick Stainless Steel	  (4*4) 1.2*2300mm	50	KC-D03
HJ-DWC2-B		  (4*4) 1.2*2300mm	100	KC-D02

Brake Inner for MTB

Model	Materials		Description	QTY	Pack
HJ-BWB1				1	KC-L01
HJ-BWB1-S	B1 Galvanized Steel		 (7*6) 1.5*2000mm	50	KC-D03
HJ-BWB1-B				100	KC-D02
HJ-BWB2				1	KC-L01
HJ-BWB2-S	B2 Stainless Steel		 (7*6) 1.5*2000mm	50	KC-D03
HJ-BWB2-B				100	KC-D02
HJ-BWS1				1	KC-L01
HJ-BWS1-S	S1 Slick Galvanized Steel		 (7*6) 1.5*2000mm	50	KC-D03
HJ-BWS1-B				100	KC-D02
HJ-BWS2				1	KC-L01
HJ-BWS2-S	S2 Slick Stainless Steel		 (7*6) 1.5*2000mm	50	KC-D03
HJ-BWS2-B				100	KC-D02
HJ-BWC1				1	KC-L01
HJ-BWC1-S	C1 Teflon Slick Galvanized Steel		 (7*6) 1.5*2000mm	50	KC-D03
HJ-BWC1-B				100	KC-D02
HJ-BWC2				1	KC-L01
HJ-BWC2-S	C2 Teflon Slick Stainless Steel		 (7*6) 1.5*2000mm	50	KC-D03
HJ-BWC2-B				100	KC-D02

Brake Inner for ROAD

Model	Materials		Description	QTY	Pack
HJ-RWB1				1	KC-L01
HJ-RWB1-S	B1 Galvanized Steel		 (6*10) 1.5*2000mm	50	KC-D03
HJ-RWB1-B				100	KC-D02
HJ-RWB2				1	KC-L01
HJ-RWB2-S	B2 Stainless Steel		 (6*10) 1.5*2000mm	50	KC-D03
HJ-RWB2-B				100	KC-D02
HJ-RWS1				1	KC-L01
HJ-RWS1-S	S1 Slick Galvanized Steel		 (6*10) 1.5*2000mm	50	KC-D03
HJ-RWS1-B				100	KC-D02
HJ-RWS2				1	KC-L01
HJ-RWS2-S	S2 Slick Stainless Steel		 (6*10) 1.5*2000mm	50	KC-D03
HJ-RWS2-B				100	KC-D02
HJ-RWC1				1	KC-L01
HJ-RWC1-S	C1 Teflon Slick Galvanized Steel		 (6*10) 1.5*2000mm	50	KC-D03
HJ-RWC1-B				100	KC-D02
HJ-RWC2				1	KC-L01
HJ-RWC2-S	C2 Teflon Slick Stainless Steel		 (6*10) 1.5*2000mm	50	KC-D03
HJ-RWC2-B				100	KC-D02

OUTER CASING DERAILLEUR & BRAKE

- The brake housing offers a smoother feel.
- A wide selection of appearance options from classic to colorful to satisfy your taste.



Display Card / No.KC-L01
Contains: 1Pcs



Display Box / No.KC-D02
Contains: 50M/Roll



Display Box / No.KC-D03
Contains: 30M/Roll

SP Casing

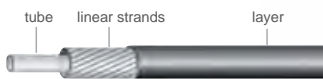

Derailleur
• O.D. 4mm

2P Casing





Brake
• O.D. 5mm

Color Option :

CC-GO01  Warm Yellow

CC-GR01  Grass Green

CC-BL01  Sky Blue

CC-EY01  Iron Gray

CC-GO02  Yellow

CC-GR02  Dark Green

CC-BL02  Medium Blue

CC-EY02  Pearl Gray

CC-GO03  Light Yellow

CC-RD01  Red

CC-PU01  Purple

CC-EY03  Gray



CC-GO04  Cream Yellow

CC-PK01  Pink



CC-WH01  White

CC-BK01  Black

Derailleur Casing

Model		Color	Description	QTY	Pack
HJ-DCS001	 SP 4mm	CC-BK01	2000mm	1	KC-L01
HJ-DCS001-S	 SP 4mm	CC-BK01	30M/ROLL	1	KC-D03
HJ-DCS001-B	 SP 4mm	CC-BK01	50M/ROLL	1	KC-D02

Brake Casing

Model		Color	Description	QTY	Pack
HJ-DCP001	 2P 5mm	CC-BK01	2000mm	1	KC-L01
HJ-DCP001-S	 2P 5mm	CC-BK01	30M/ROLL	1	KC-D03
HJ-DCP001-B	 2P 5mm	CC-BK01	50M/ROLL	1	KC-D02

UNIVERSAL BRAKE GROUP SET



- Durable, rustproof and kink-free.
- Double-ended cables, suitable for mountain bikes and road bikes.



Sqare Box / No.KC-P04
Contains: 1 Set

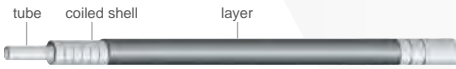

Brake 2P Casing

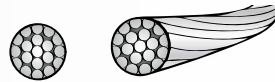

S2: Slick Stainless Steel Wire

EACH PACK CONTAINS

- 1 SP Casing CC-BK01 Ø5.0mm Length: 3000mm
- 1 Slick Stainless Steel Wire Ø1.5mm Front Length: 1350mm
- 1 Slick Stainless Steel Wire Ø1.5mm Rear Length: 2350mm
- 6 Cable End Caps 
- 3 O-rings for wire 
- 4 Frame Protectors 
- 2 Inner Wire Caps 
- 2 Cable Cross 

Color Option Of Casing :

CC-GO01  Warm Yellow	CC-GR01  Grass Green	CC-BL01  Sky Blue	CC-EY01  Iron Gray
CC-GO02  Yellow	CC-GR02  Dark Green	CC-BL02  Medium Blue	CC-EY02  Pearl Gray
CC-GO03  Light Yellow	CC-RD01  Red	CC-PU01  Purple	CC-EY03  Gray
CC-GO04  Cream Yellow	CC-PK01  Pink	CC-WH01  White	CC-BK01  Black

UNIVERSAL SHIFT GROUP SET



- Durable, rustproof and kink-free.
- Duple-ended cables, suitable for Shimano®/SRAM® and Campagnolo®



Sqare Box / No.KC-P04
Contains: 1 Set



Derailleur SP Casing

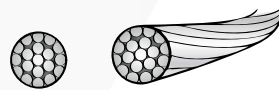



S2: Slick Stainless Steel Wire

EACH PACK CONTAINS

- 1 SP Casing CC-BK01 Ø4.0mm Length: 2700mm
- 1 Slick Stainless Steel Wire Ø1.2mm Front Length: 1500mm
- 1 Slick Stainless Steel Wire Ø1.2mm Rear Length: 2300mm
- 9 Cable End Caps 
- 6 O-rings for wire 
- 4 Frame Protectors 
- 6 Inner Wire Caps 
- 2 Cable Cross 

Color Option Of Casing :

CC-GO01  Warm Yellow	CC-GR01  Grass Green	CC-BL01  Sky Blue	CC-EY01  Iron Gray
CC-GO02  Yellow	CC-GR02  Dark Green	CC-BL02  Medium Blue	CC-EY02  Pearl Gray
CC-GO03  Light Yellow	CC-RD01  Red	CC-PU01  Purple	CC-EY03  Gray
CC-GO04  Cream Yellow	CC-PK01  Pink	CC-WH01  White	CC-BK01  Black



ALHONGA

www.ALHONGA.com

ALHONGA ENTERPRISE CO., LTD.

Tel : +886-4-771-6666 / Fax : +886-4-771-5566

